

ROTEL hi-fi

ROTEL hi-fi

ROTEL hi-fi

ROTEL hi-fi

ROTEL hi-fi

ROTEL hi-fi

ROTEL hi-fi

ROTEL hi-fi

ROTEL hi-fi

ROTEL hi-fi

ROTEL hi-fi

ROTEL hi-fi

ROTEL hi-fi

ROTEL hi-fi

ROTEL hi-fi

ROTEL hi-fi

ROTEL hi-fi

ROTEL hi-fi

ROTEL hi-fi

ROTEL hi-fi

RCD-971

STEREO COMPACT DISC PLAYER

STEREO-CD-PLAYER

LECTEUR DE DISQUES COMPACTS STÉRÉO

LECTOR DE DISCOS COMPACTOS



Owner's Manual

Guide d'utilisation

Bedienungsanleitung

Manual de Instrucciones

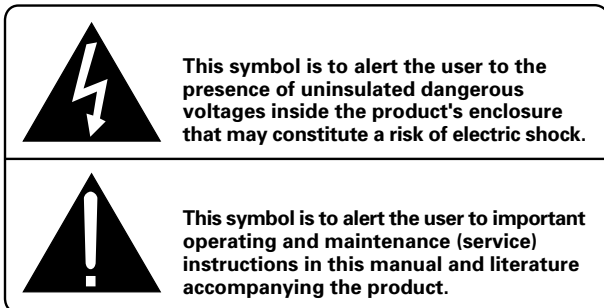
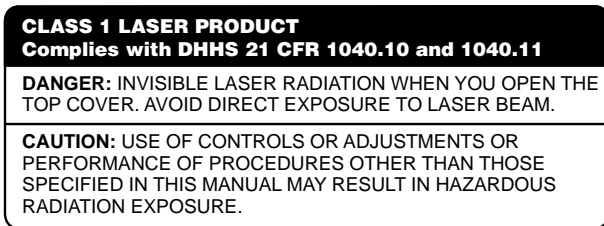
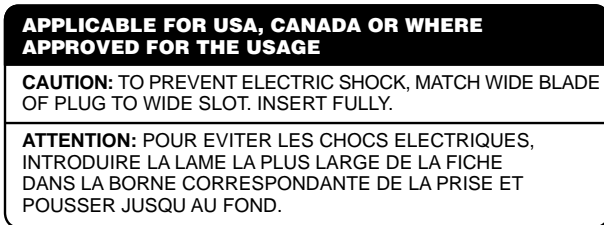

WARNING:
There are no user serviceable parts inside. Refer all servicing to qualified service personnel.

WARNING:
To reduce the risk of fire or electric shock, do not expose the RCD-971 to moisture or water. Do not allow foreign objects to get into the enclosure. If the unit is exposed to moisture, or a foreign object gets into the enclosure, immediately disconnect the power cord from the wall. Take the unit to a qualified service person for inspection and necessary repairs.

Read all the instructions before connecting or operating the RCD-971. Keep this manual so you can refer to these safety instructions.

Heed all warnings and safety information in these instructions and on the product itself. Follow all operating instructions.

Clean the RCD-971 only with a dry cloth or a vacuum cleaner.

Keep the ventilation inlets on the unit unobstructed. For example, do not place the unit on a bed, sofa, rug, or similar surface that could block the ventilation slots. If the RCD-971 is placed in a bookcase or cabinet, there must be sufficient clearance around the unit and ventilation of the cabinet to allow proper cooling.

Keep the RCD-971 away from radiators, heat registers, stoves, or any other appliance that produces heat.

The RCD-971 must be connected to a power supply only of the type and voltage specified on the rear panel of the unit.

Connect the RCD-971 to the power outlet only with the supplied 2-pin polarized power supply cable or an exact equivalent. Do not modify the supplied cable in any way. Do not attempt to defeat grounding and/or polarization provisions. The cable should be connected to a 2-pin polarized wall outlet, matching the wide blade of the plug to the wide slot of the receptacle. Do not use extension cords.

Do not route the power cord where it will be crushed, pinched, bent at severe angles, exposed to heat, or damaged in any way. Pay particular attention to the power cord at the plug and where it exits the back of the unit.

The power cord should be unplugged from the wall outlet if the unit is to be left unused for a long period of time.

Immediately stop using the RCD-971 and have it inspected and/or serviced by a qualified service agency if:

- The power supply cord or plug has been damaged.
- Objects have fallen into or liquid has been spilled into the unit.
- The unit has been exposed to rain.
- The unit shows signs of improper operation
- The unit has been dropped or damaged in any way

Place the RCD-971 on a fixed, level surface strong enough to support its weight. Do not place the RCD-971 on a moveable cart that could tip over.



Figure 1: Controls and Connections / German Translation?
 Commandes et prises de connexion / Controles y Conexiones

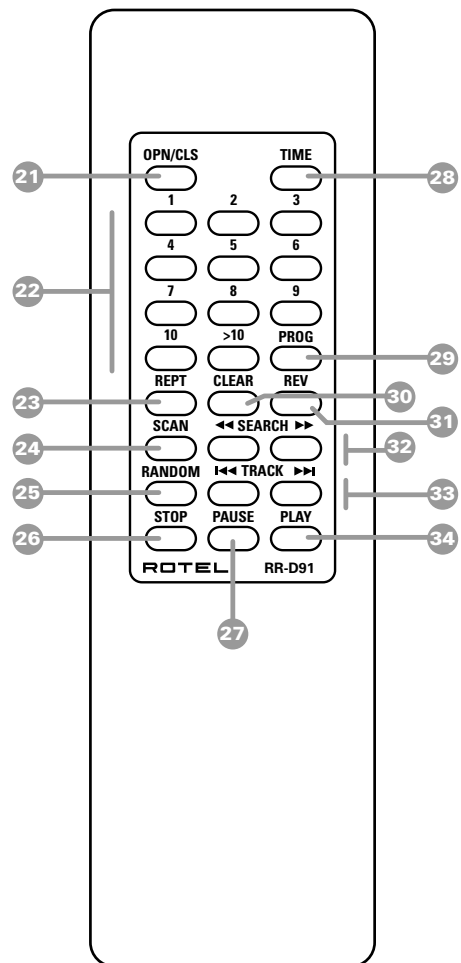
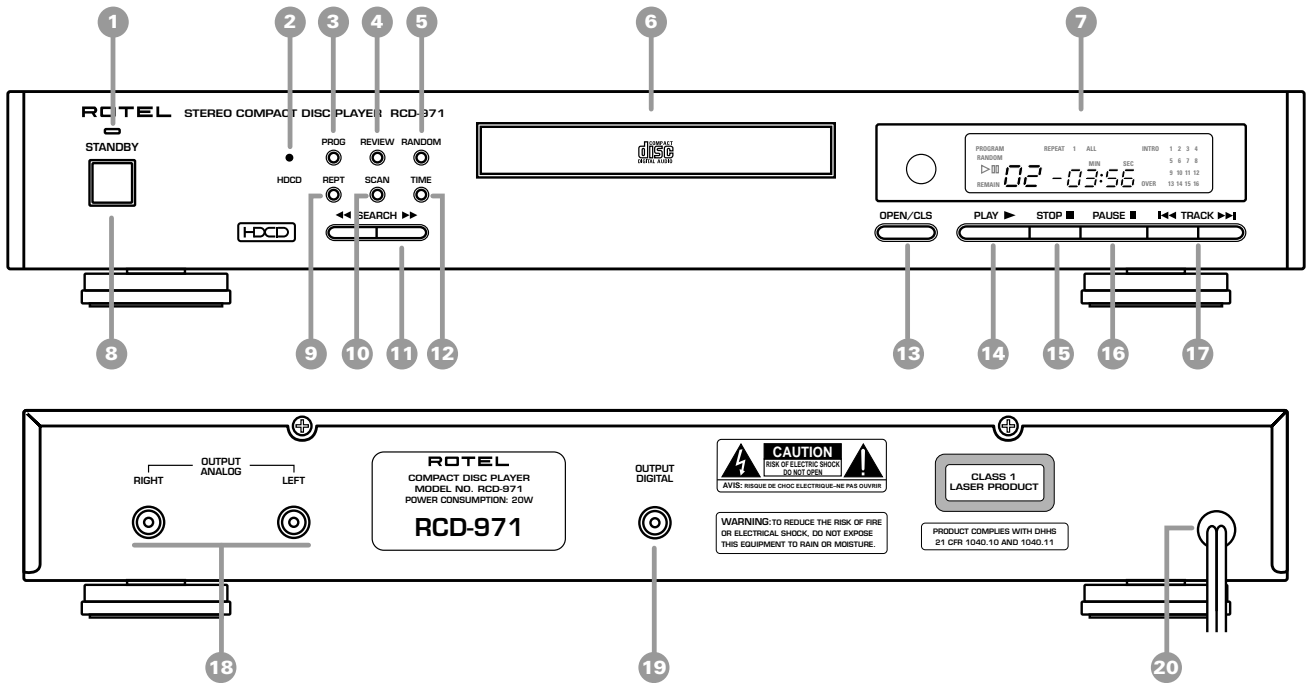

Figure 2: Analog Outputs / German Translation / Sorties analogiques / Salidas Analógicas

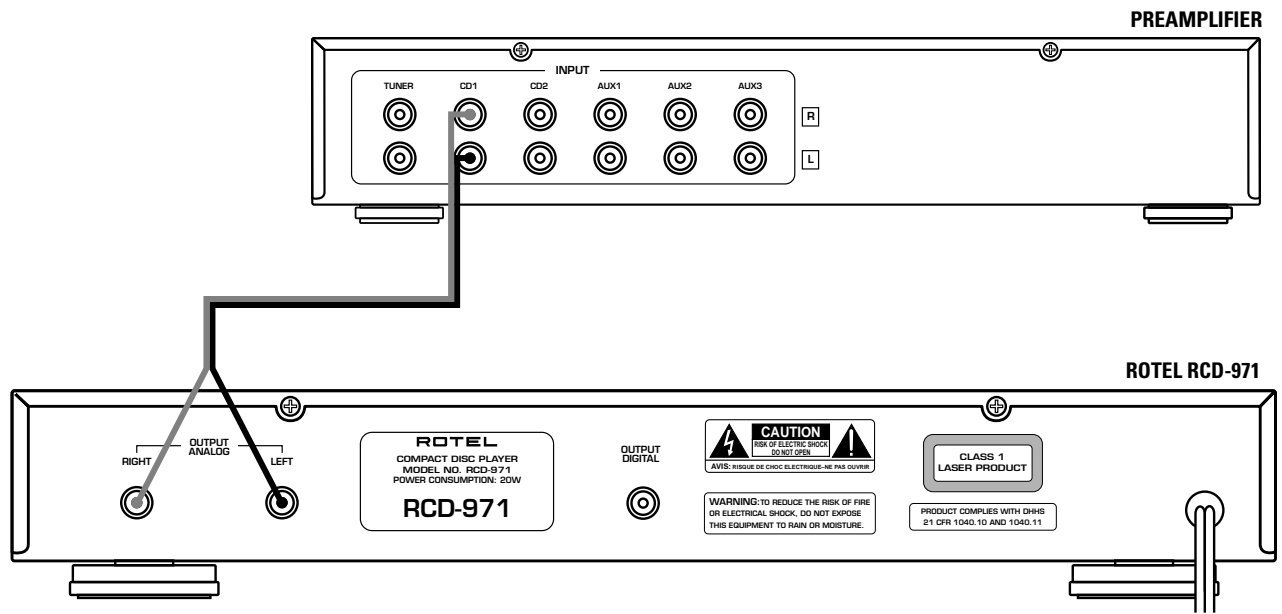
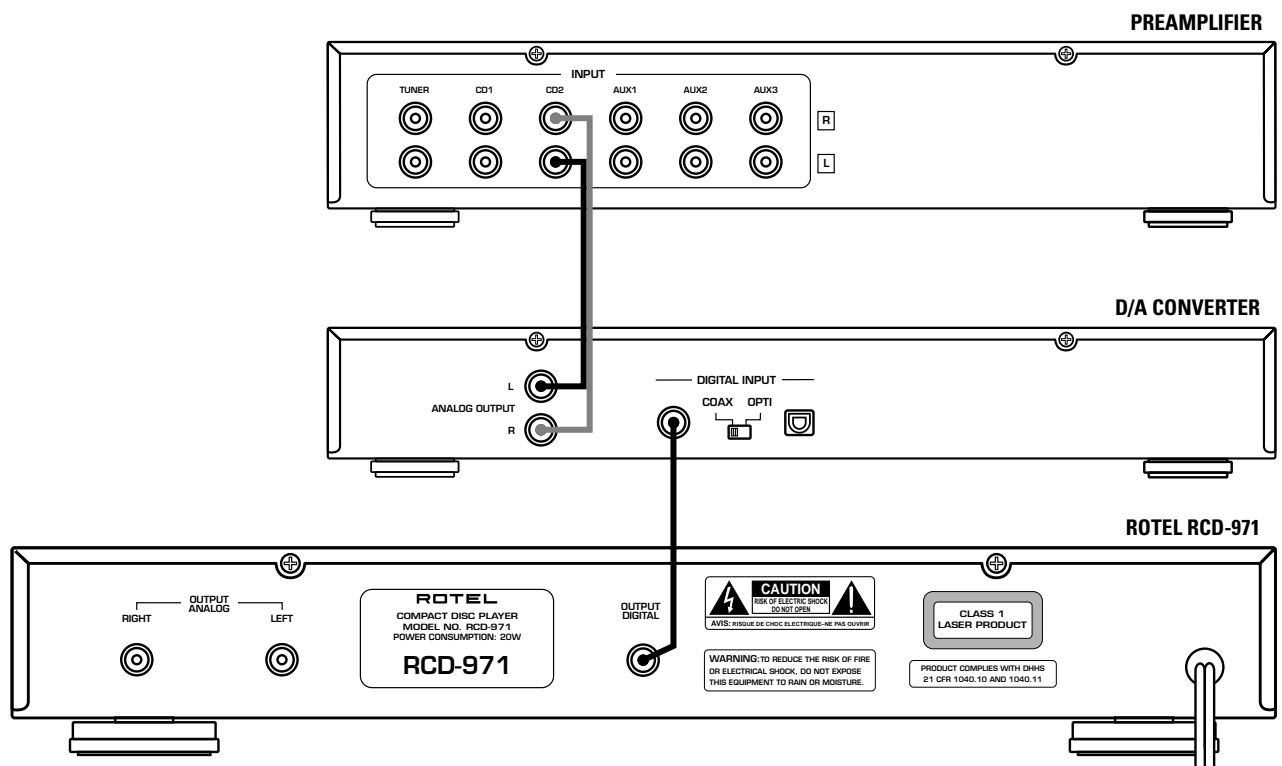

Figure 3: Digital Outputs / German Translation? / Sorties numériques / Salidas Digitales



Contents

[circled numbers refer to illustration]

About Rotel _____	1
Getting Started _____	1
A Few Precautions	1
Placement	2
AC Power and Control _____	2
AC Power Input 20	2
Power Switch 8 and Power Indicator 1	2
Output Connections _____	2
Analog Outputs 18	2
Digital Output 19	2
Operation _____	2
Infrared Remote Control	3
Display 7	3
Disc Drawer 6	3
Transport Control Buttons _____	3
OPEN/CLOSE Button 13 21	3
PLAY Button 14 34	3
STOP Button 15 26	3
PAUSE Button 16 27	3
TRACK Buttons 17 33	3
DIRECT ACCESS Buttons (remote only) 22	3
SEARCH Buttons 11 32	4
Additional Features _____	4
HDCD 2	4
PROGRAM Button 3 29	4
REVIEW Button 4 31	4
CLEAR Button (remote only) 30	4
RANDOM Button 5 25	5
REPEAT Button 9 23	5
SCAN Button 10 24	5
TIME Button 12 28	5
Specifications _____	5

About Rotel

A family whose passionate interest in music led them to manufacture high fidelity components of uncompromising quality founded Rotel over 30 years ago. Through the years that passion has remained undiminished and the family goal of providing exceptional value for audiophiles and music lovers regardless of their budget, is shared by all Rotel employees.

The engineers work as a close team, listening to, and fine tuning each new product until it reaches their exacting musical standards. They are free to choose components from around the world in order to make that product the best they can. You are likely to find capacitors from the United Kingdom and Germany, semi conductors from Japan or the United States, while toroidal power transformers are manufactured in Rotel's own factory.

Rotel's reputation for excellence has been earned through hundreds of good reviews and awards from the most respected reviewers in the industry, who listen to music every day. Their comments keep the company true to its goal - the pursuit of equipment that is musical, reliable and affordable.

All of us at Rotel, thank you for buying this product and hope it will bring you many hours of enjoyment.

Getting Started

Thank you for purchasing the Rotel RCD-971 single disc Stereo Compact Disc Player. With its precision transport, 20-bit 8-times oversampling digital circuitry, dual-differential 20-bit D/A converters, and Rotel's Balanced Design, the RCD-971 ensures the highest level of audio performance. When used in a high-quality audio system, your Rotel CD player will provide years of enjoyment.

A Few Precautions

Please read this manual carefully. In addition to installation and operating instructions, it provides valuable information on various RCD-971 system configurations as well as general information that will help you get optimum performance from your system. Please contact your authorized Rotel retailer for answers to any questions you might have. In addition, all of us at Rotel welcome your questions and comments.

Save the RCD-971 shipping carton and all enclosed packing material for future use. Shipping or moving the RCD-971 in anything other than the original packing material may result in severe damage that is not covered by the warranty.

Fill out and send in the owner's registration card packed with the RCD-971. Also be sure to keep the original sales receipt. It is your best record of the date of purchase, which you will need in the event warranty service is required.

Placement

Use common sense when placing the RCD-971 in a cabinet or when stacking other equipment. Make sure that the shelf or cabinet can support its weight. Do not stack heavy components on top of the RCD-971. Avoid placing the unit where it may be subject to excessive heat such as on top of a large power amplifier or near a heat register. For best performance, avoid placing the unit where it may be subject to vibration, such as near a speaker.

AC Power and Control

AC Power Input 20

Your RCD-971 is configured at the factory for the proper AC voltage in the country where you purchased it (either 115 volts or 230/240 volts). The AC line configuration is noted on a decal on the back panel.

Note: Should you move your CD player to another country, it may be possible to reconfigure it for use on a different line voltage. Do not attempt to perform this conversion yourself. Opening the enclosure of the RCD-971 exposes you to dangerous voltages. Consult a qualified service person or the Rotel factory service department for information.

The RCD-971 should be plugged directly into a 2-pin polarized wall outlet or into the switched outlet on another component in your audio system. Do not use an extension cord.

Be sure the power switch on the front panel of the RCD-971 is turned off (in the "out" position). Then, connect the supplied power cord to the AC power receptacle on the rear of the unit and the AC power outlet.

If you are going to be away from home for an extended period of time such as a month-long vacation, it is a sensible precaution to unplug your CD player (as well as other audio and video components) while you are away.

Power Switch 8 and Power Indicator 1

The power switch is located on the front panel of your CD player. To turn the CD player on, push the switch in. The LED indicator above the switch and the Display will light up, indicating that the CD player is turned on. To turn the CD player off, push the button again and return it to the "out" position.

Note: If you are using a switched outlet to turn on and off your CD player, you should leave the power switch in the "on" position. When AC power is applied to the unit, it will power up in fully active mode.

Output Connections

The RCD-971 gives you a choice of two different kinds of output connections — an analog output signal from the built-in D/A converter for use with conventional analog audio components and a coax digital output which provides an unprocessed digital data signal for use with outboard D/A converters or digital processors.

Note: To prevent loud noises that neither you nor your speakers will appreciate, make sure the CD player is turned off when you make any signal connections.

Analog Outputs 18

[See Figure 2 for wiring illustration]

A pair of standard RCA jacks supplies an analog output signal from the RCD-971 to the source inputs of an audio preamplifier, integrated amplifier, or receiver.

Select high quality audio interconnect cables. Connect the left channel output of the RCD-971 to the left channel source input on the preamplifier or other component. Connect the right output of the RCD-971 to the right channel source input on the preamplifier or other component.

Digital Output 19

[See Figure 3 for wiring illustration]

If you are using an outboard D/A converter or other digital processor, you will need an unprocessed digital data stream from the RCD-971, taken before the built-in D/A converter. This signal is supplied by the RCD-971's back-panel digital output jack.

Using a standard 75 ohm coax digital cable, connect the RCD-971's coax digital output to the coax digital input connector on the outboard D/A converter.

Operation

The RCD-971 can be operated using its front panel buttons or from corresponding buttons on the supplied infrared remote control. Specific instructions for each of these controls are detailed below. Most of the buttons are duplicated on the front panel and on the IR remote control. However, there are a few exceptions where the buttons are only available on one or the other. These exceptions are noted in the instructions.

Infrared Remote Control

Before using the IR remote control, it is necessary to install two "AAA" batteries (supplied). Remove the plastic cover on the back of the IR remote, install the batteries (observing the + and – polarity indications), and reinstall the cover.

To use the IR remote control, aim it at the IR sensor located in the Display area on the front panel of the RCD-971.

Display 7

A lighted Display on the front panel of the RCD-971 provides useful information about the status of the unit, activation of special features, and track/time information for the disc being played. Each of these indicators is described in the detailed operating instructions that follow.



Disc Drawer 6

A motor-driven disc drawer, located in the center of the RCD-971, slides out to accept a compact disc and retracts to play the disc.

Place the compact disc in the drawer label-side up. Make sure the disc is properly centered in the tray.

The drawer can be closed in two ways: pushing the OPN/CLS button or pushing the PLAY button.

Transport Control Buttons

These buttons provide basic control functions for the disc transport mechanism. Except where noted, all functions are available on the RCD-971 front panel and the IR remote control. The circled numbers provide a convenient reference for finding the button on the illustrations of the RCD-971 and the IR remote control at the front of this manual.

OPEN/CLOSE Button 13 21

When the transport disc drawer is closed, pressing this button automatically opens the drawer. To close the drawer, press this button again. The drawer can also be closed by pressing the PLAY button.

When the drawer is open, the Display will read "OPEN". When it is closed with no disc, the display will read "NO DISC". When the drawer closes with a disc inserted, the Display will indicate the number of tracks on the disc and the total time of the disc in minutes and seconds.

PLAY Button 14 34

Press the PLAY button to start playing the disc. If the disc drawer is open, it will close automatically. The number of the track being played and the elapsed time will be shown in the display, along with the PLAY indicator.

Normally, the disc will start playing with the first track. However, you can select a different track using the TRACK buttons or the DIRECT ACCESS buttons (see below) before pressing the PLAY button to start playing a different selection.

STOP Button 15 26

This button stops a disc that is playing and resets the player, i.e. if play is resumed, the disc will start over from the first track. Pressing the STOP button twice quickly in succession cancels any programmed selections (see below).

PAUSE Button 16 27

This button is used to temporarily suspend play. The disc continues to spin and play will be resumed from the current position. The PAUSE indicator will light in the Display.

To resume playing the disc, press the PAUSE button again or press the PLAY button.

TRACK Buttons 17 33

These buttons are used to select tracks on the disc. When a disc is playing, pressing the right TRACK button advances to the beginning of the next track. Pressing the left TRACK button returns to the beginning of the current track. Pressing twice quickly in succession returns to the beginning of the previous track. The new track number appears in the Display.

These buttons are also used to select a track before pressing the PLAY button or when memorizing tracks for the PROGRAM play mode (see below). These selections are made by continuously pressing the TRACK buttons until the desired track is reached.

In PROGRAM mode, the TRACK buttons advance or reverse to the next track in the memorized selection list.

DIRECT ACCESS Buttons (remote only) 22

These eleven numeric buttons (labeled 1 through 10 and >10) are used to directly access a track from the IR remote control instead of stepping through the tracks using the TRACK buttons.

The first ten tracks on a disc can be selected by pressing the corresponding button. For example, to play the third track, press the 3 button on the remote control.

When accessing track numbers greater than 10, press the >10 button followed by the track number. For example, to select track 12, press the >10 button followed by the 1 button and then the 2 button.

The number of the selected track will appear in the main numeric area at the center of the Display.

There is also a four by four matrix of track numbers (1 – 16) located at the right side of the display. This display indicates all of the tracks on the disc. If there are more than 16 tracks on the disc, all of the digits will light accompanied by the word OVER, regardless of which track is playing. This matrix is independent of the main numeric area of the Display, which will always indicate the currently playing track, even if above 16.

The DIRECT ACCESS buttons may also be used to memorize tracks in PROGRAM mode (see below).

SEARCH Buttons 11 32

These buttons fast forward or fast reverse through the currently playing disc as long as they are pressed. While the buttons are pressed, you will hear high-speed audio. Releasing the buttons returns to PLAY mode.

Additional Features

These convenience features add extra functionality to the RCD-971, including the ability to play high-definition HDCD discs, to memorize a group of tracks to be played, to repeat a disc, program, or track over and over, to play the tracks on a disc in random order, to automatically play the first 10 seconds of each track, and to select from several available time displays.

HDCD 2

HDCD® is an encoding technique that allows a CD to have greater effective dynamic range, reduced distortion, and increased detail. When playing HDCD encoded discs, the RCD-971 can reproduce as much as 20-bit dynamic range. HDCD discs are identified by an HDCD logo on the package.

No user action is required to play an HDCD recording. The CD player automatically senses HDCD encoding and enables the circuitry. The HDCD LED on the front panel will light to indicate that an HDCD disc is being played.

PROGRAM Button 3 29

This button, labeled PROG, allows you to memorize as many as 20 tracks on the current disc for playback in a specific order. For example, you could instruct the RCD-971 to play track 5, followed by track 3, followed by track 8. To begin a program:

1. Insert a disc and press the OPEN/CLOSE button to close the drawer. The RCD-971 will read the contents of the disc.
2. Press the PROGRAM button on the front panel or the remote control. The PROGRAM indicator will light up in the Display, along with "P:00" indicating that the unit is waiting for the first track to be memorized.

3. To program tracks from the handheld remote control, enter the first track number using the DIRECT ACCESS buttons. Your selection will be memorized automatically and the Display indicator will change to "P:01", indicating that one track has been memorized. Continuing entering the rest of your selections using the DIRECT ACCESS buttons. Note that there is no need to press the PROGRAM button as each selection is memorized as it is entered.

4. To program tracks from the front panel, select the first track number using the TRACK buttons. The track number and the program number in the display will flash for 3 seconds. While the display is flashing, press the PROGRAM button to memorize your selection. Note that once the flashing stops, you will no longer be able to memorize your selection. To memorize additional tracks, select them with the TRACK buttons, pressing the PROGRAM button after each selection.

Once you have memorized a play list, the RCD-971 remains in PROGRAM mode until you open the disc drawer or press the STOP button twice in succession. If you press the PLAY button, the memorized program will play instead of the entire disc, starting with the first selection in the memorized list.

When a PROGRAM has been memorized, most functions that would normally effect the entire disc operate on just the memorized program. For example, the TRACK buttons advance to the next track in the memorized program, not the next track on the disc. Likewise, the REPEAT button (see below) continuously plays the memorized program, not the entire disc.

REVIEW Button 4 31

This button is used to review the memorized tracks in PROGRAM mode. Press the button and the first memorized track number will appear in order in the Display, flashing for approximately five seconds. Pressing the REVIEW button again while the track number is flashing will continue the review sequence, showing the next memorized track. Continue pressing the REVIEW button to see the complete memorized track list.

If you do not press the REVIEW button while the track number is flashing, the review process is terminated and the unit resumes whatever mode it was in before you started to review, except that the last reviewed track number will remain active and shown in the display.

Note that you may remove a selection from the play list during the review procedure using the CLEAR button, as described below.

CLEAR Button (remote only) 30

This button allows you to remove a track selection from the memorized program play list during the review procedure described above. Follow the review procedure until the desired track number is flashing. Then, instead of pressing the REVIEW button to continue, remove the displayed track by pressing the CLEAR button while the number is still flashing. You may then continue the review procedure.

RCD-971

**STEREO COMPACT DISC PLAYER
STEREO-CD-PLAYER
LECTEUR DE DISQUES COMPACTS STÉRÉO
LECTOR DE DISCOS COMPACTOS**

The Rotel Co., Ltd.

10-10 Shinsen-Cho
Shibuya-Ku
Tokyo 150-0045
Japan

Phone: +81-3-5458-5325

Fax: +81-3-5458-5310

Rotel of America

54 Concord Street
North Reading, MA 01864-2699
USA

Phone: 978-664-3820

Fax: 978-664-4109

Rotel Deutschland

Kleine Heide 12
D-33790 Halle/Westf.
Germany

Phone: 05201-87170

Fax: 05201-73370

ROTEL *hi-fi*

ROTEL *hi-fi*

ROTEL *hi-fi*

ROTEL *hi-fi*

ROTEL *hi-fi*

ROTEL *hi-fi*

ROTEL *hi-fi*

ROTEL *hi-fi*

ROTEL *hi-fi*

ROTEL *hi-fi*

ROTEL *hi-fi*

ROTEL *hi-fi*

ROTEL *hi-fi*

ROTEL *hi-fi*

ROTEL *hi-fi*

ROTEL *hi-fi*

ROTEL *hi-fi*

ROTEL *hi-fi*

ROTEL *hi-fi*

ROTEL *hi-fi*